

LNS, YOUR UNIQUE PARTNER FOR YOUR PERIPHERALS



COOLANT MANAGEMENT
SYSTEMS



AIR FILTRATION
SYSTEMS



BAR FEEDING
SYSTEMS



CHIP
MANAGEMENT
SYSTEMS



YOUR ONE-STOP-SHOP
FOR MACHINE-TOOL PERIPHERALS

OVER 40 YEARS OF SERVICE, PERFORMANCE AND INNOVATION

For over 40 years, LNS has been based in the commune of Orvin, the perfect location in the heart of Switzerland's Jura region, the hub of the bar turning industry.

Since it was founded, LNS has been devoted to helping optimise the performance of their machine tools whilst increasing their productivity and safeguarding their operators.

Our group has become a world leader in the domain of peripherals for machine tools. Our worldwide presence with 8 production sites, strategically located across the globe, gives us proximity to the market and allows us to position ourselves as a local supplier of reliable products and to offer a quick service. Market coverage is ensured by a network of subsidiaries and exclusive agents that we have built up ourselves.

LNS currently employs more than 800 members of staff, inventing, manufacturing, assembling, promoting, selling and maintaining a large range of products designed for equipping machine tools. The common denominators of these products that we group under the heading «peripherals» are: performance, quality, reliability and ease of use.

Thanks to the efforts made by all of our employees and the continuous investment in innovation, we aim to continue to offer unrivalled value to all our customers by providing the most advanced technology at the best price for many decades to come.

Headquarter, Orvin, Switzerland



LUXURY &
HIGH PRECISION



MEDICAL



ELECTRONICS &
CONNECTORS

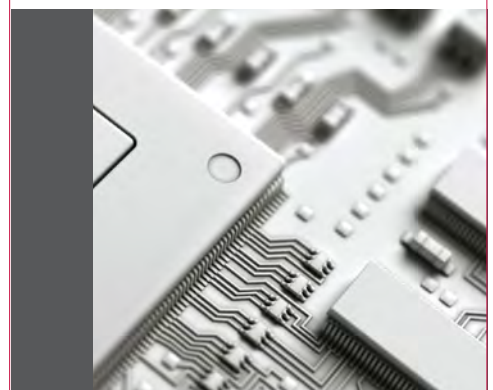

LNS OFFERS A WIDE RANGE OF PRODUCTS

TO ENABLE YOU TO MAXIMISE YOUR PRODUCTIVITY AND YOUR RETURN ON INVESTMENT.

BAR FEEDERS

p. 4 to 13

With more than 150,000 units installed across the world, LNS bar feeders are universally recognised for their exceptional quality and performance. Our bar feeders ensure maximum productivity on all types of fixed or sliding headstock lathes, even in the most varied of applications.

From entry level solutions to sophisticated equipment, our vast range of products covers all manufacturing approaches (short bars, long bars or half-bars), whilst offering unbeatable reliability and flexibility thanks to systems which enable the quickest diameter changes in the world.

CHIP CONVEYORS

p. 14 to 19

LNS designs and produces chip conveyors and complete chip removal systems for all types of machine.

With more than 130,000 units installed, LNS conveyor systems are available in a large range of models for all types of materials and all kinds of chip. They can be fitted with coolant filtration systems effective to 50 microns.

COOLANT MANAGEMENT

p. 20 to 21

LNS supplies a complete range of coolant management systems which guarantee optimal performance of your coolant system.

LNS high-pressure cooling systems significantly increase machining speeds, extend the service life of the cutting tool and reduce expenditure on tooling.

AIR FILTRATION SYSTEMS

p. 22 to 24

LNS designs, produces and commercialises a complete range of air filtration systems designed to counter contamination problems experienced in the workshop. Over 10'000 air filtration systems have already been installed. Thanks to their ultra-resilient construction and high level of reliability, oil mist collectors eliminate any mist, vapours and smoke, thereby helping to ensure a safe and healthy working environment and protect your production equipment.

TRANSPORTATION



ENERGY, OIL & GAS



MACHINERY & PRODUCTION

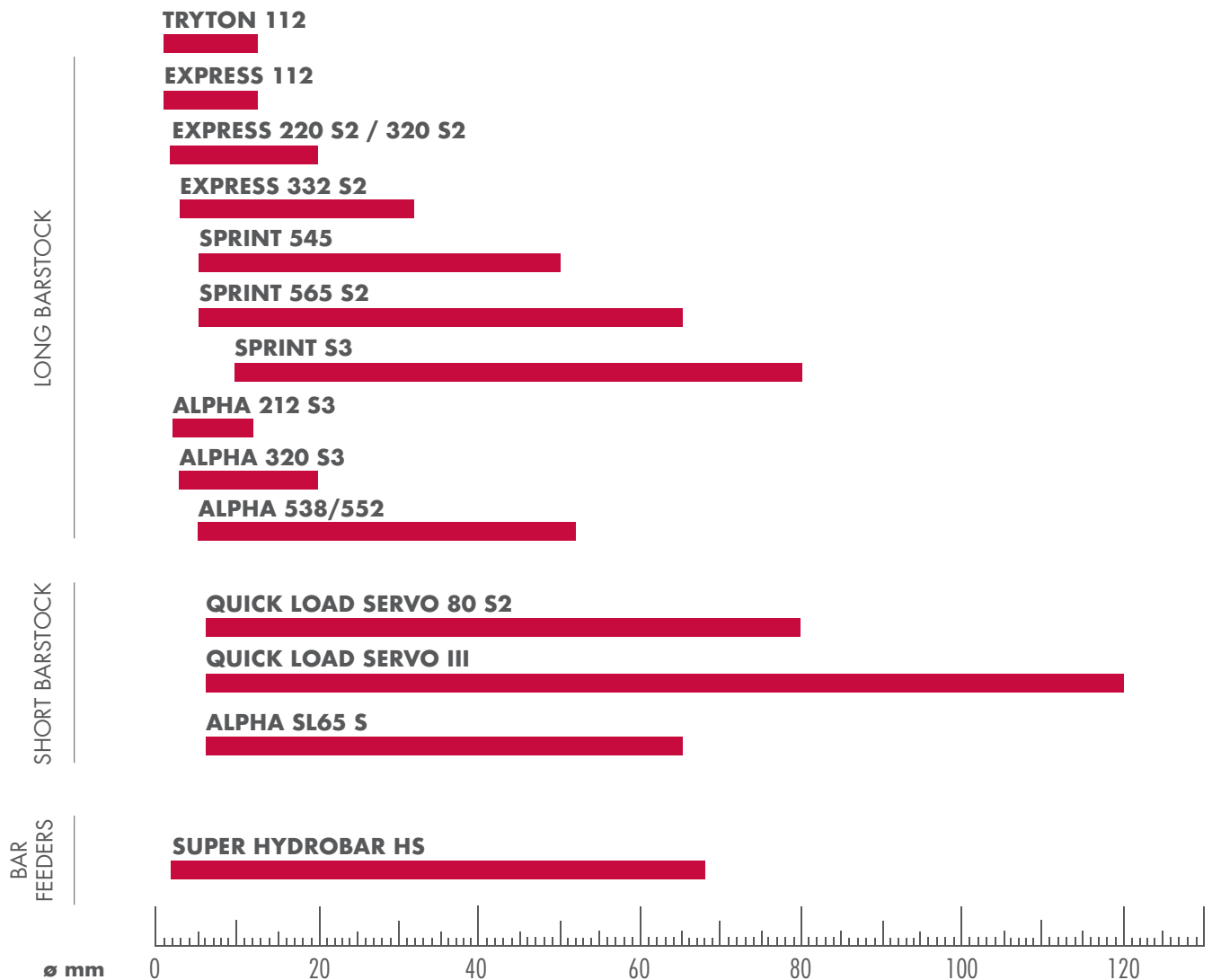

TABLE OF CONTENTS

BAR FEEDING SYSTEMS

TRYTON 112 EXPRESS 112	5	ALPHA 320 S3 ALPHA 538/552	9
EXPRESS 220 S2 / 320 S2 EXPRESS 332 S2	6	QUICK LOAD SERVO 80 S2 QUICK LOAD SERVO III	10
SPRINT 545 SPRINT 565 S2	7	ALPHA SL65 S PB 80	11
SPRINT S3 ALPHA 212 S3	8	SUPER HYDROBAR HS SE880	12
		SPINDLE REDUCTION TUBES (SINGLE-PIECE) SPINDLE REDUCTION TUBES (MULTIPLE PIECES) COLLETS AND ROTATING SLEEVES	13

DIAMETER RANGE





TRYTON 112

AUTOMATIC BAR FEEDER – LONG BARSTOCK



The Tryton 107/112 is an automatic magazine bar feeder featuring high performance for small diameter and is designed for camshaft controlled screw machines and Swiss-style CNC machines. The guiding technology on the Tryton is based on a hydrodynamic oil support in totally enclosed guide tubes.

- Hydrobar® technology
- High rotation speeds on diameter range
- Quick diameter changeover
- Designed for specific materials production (gold, plastic, etc.)

Capacity		TRYTON 112
Available versions		CNC / Cames
Diameter	mm	ø 1 – 12.7
Bar length 2m/3m/12"/4m	mm	2100/3200/3710/4200
Loading system		Barrel
Loading capacity	Bars	A : 45 (d 1-5) B : 36 (d 1-7) C : 24 (d 3-10) D : 24 (d 4-12.7)
Loading side		Right/Left
Applications		
Type of headstock		Fixed/Sliding
Synchronization		Pressure valve
Remnant length	mm	Min. 70/Max. 230
Diameter change		
Partial change	min	2 (within the diameter range for the tube)
Complete change	min	5 – 10 (with the hybrid barrel)
Driving system		
Drive		Hydraulic pressure
Guide		Hydrodynamic/tube
Oil		25L, ISO VG 100
Options		
Hybrid barrel		A+C: 2x14 bars (d 1-10) B+D: 2x14 bars (d 1-12.7)
Barrel pivoting		Yes



EXPRESS 112

AUTOMATIC BAR FEEDER – LONG BARSTOCK



Innovative and efficient, the Express 112 provides maximum productivity and sets a new standard offering the smallest footprint in its class. The bar feeder ensures perfect guiding of bars at the highest speeds, over the entire range of diameters thanks to the Hydrobar® technology.

- Especially suitable for high-precision industry
- Ergonomic
- Compact
- Hydrobar® technology
- Colour touchscreen with parts library

Capacity		
Diameter	mm	ø 0.8 – 12
Bar length 2m/3m	mm	2200/3200
Loading system		Screw
Loading capacity		Up to 30 bars
Loading side		Right/Left
Applications		
Type of headstock		Fixed/Sliding
Synchronization		Electronic "3S"
Remnant length	mm	Min. 70/Max. 230
Remote control		Colour touchscreen with library of 500 parts
Diameter change		
Partial change	min	2 (in the same channels)
Complete change	min	6 (for all guide components)
Driving system		
Motor		Servo
Drive		Belt
Guide		Hydrodynamic/Guiding channel
Oil		30L, ISO VG 32 or 68
Options		
350 mm longitudinal movement		
Adjustable 2-positions longitudinal movement		
External bar storage system		



EXPRESS 220 S2 / 320 S2

AUTOMATIC BAR FEEDERS – LONG BARSTOCK



The Express 220 S2 / 320 S2 offers the best loading capacity/length ratio in its category. Its high-end components and manufacturing quality ensure perfect alignment and operation, making it the ideal choice for users looking to guarantee years of production. In addition, it can be quickly and economically equipped with specific options at any time.

- Hydrobar® technology
- Rapid diameter changes
- Patented LNS “3S” synchronization system
- Complete catalogue of options
- Colour touchscreen with parts library

Capacity		EXPRESS 220 S2	EXPRESS 320 S2
Diameter	mm	ø 2 – 23*	ø 3 – 23*
Bar length 2m/3m/12"/4m	mm	2200/3200/3800/4200	
Loading system		Lateral magazine	
Loading capacity	mm	240**	
Loading side		Right/Left	
Applications			
Type of headstock		Fixed/Sliding	
Remnant length	mm	Min. 70/Max. 400	
Synchronization		Electronic “3S”	PLC/Servo motor
Remote control		Colour touchscreen with library of 500 parts	
Diameter change			
Partial change	min	2 (in the same channels)	
Complete change	min	8 (for all guide components)	
Driving system			
Motor		Servo	
Drive		Chain	
Guide		Guiding channel and “active cover”	Guiding channel
Oil		30L, ISO VG 100	
Options			
450 mm longitudinal movement			
Adjustable 2-positions longitudinal movement			
Extension to 26 mm *			
Extension of the magazine up to 340 mm for bars from 4 to 12 mm **			



EXPRESS 332 S2

AUTOMATIC BAR FEEDER – LONG BARSTOCK



The Express 332 S2 is an automatic magazine bar feeder designed for short, medium and long production runs. The conception of this bar feeder permits fast diameter changeover and very short set up times. The hydrodynamic support in the guiding channels allows optimal RPM without vibration.

- Hydrobar® technology
- Automatic diameter set up
- Complete range of options
- Colour touchscreen with parts library

Capacity			
Diameter	mm	ø 3 – 32 (34)	
Bar length 2m/3m/12"/4m	mm	2200/3200/3800/4200	
Loading system		Lateral magazine	
Loading capacity	mm	270	
Loading side		Right/Left	
Applications			
Type of headstock		Fixed/Sliding	
Synchronization		PLC/Servo motor	
Remnant length	mm	Min. 90/Max. 400	
Remote control		Colour touchscreen with library of 500 parts	
Diameter change			
Partial change	mins	2 (in the same channels)	
Complete change	mins	8 (for all guide components)	
Driving system			
Motor		Servo	
Drive		Chain	
Guide		Hydrodynamic/Guiding channel	
Oil		80L, ISO VG 100	
Options			
470 mm longitudinal movement			
Adjustable 2-positions longitudinal movement			



SPRINT 545

AUTOMATIC BAR FEEDER – LONG BARSTOCK

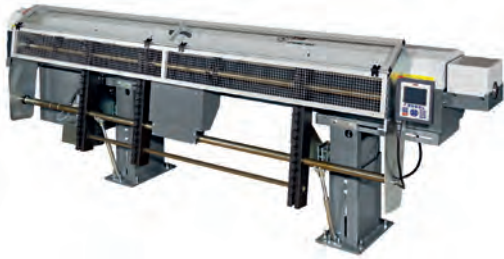

An automatic bar feeder for fixed or sliding headstock lathes, this device guarantees maximum productivity thanks to its side chain loading rack system and offers the highest autonomy on the market as standard, all within a compact footprint. Depending on the workpieces to be machined, the SPRINT 545 is designed to adapt to any type of production requiring frequent diameter changes, whether very large or medium runs.

- Hydrobar® technology
- Rapid diameter changes
- Highest autonomy on the market
- Longitudinal movement with 2 positions
- Colour touchscreen with parts library

Capacity		
Diameter	mm	ø 5 – 45
Bar length 2m/3m/12"/4m	mm	2200/3200/3800/4200
Loading system		Side chain elevator
Loading capacity		18 x ø 38 mm or 11 x ø 45 mm
Loading side		Right/Left
Applications		
Type of headstock		Fixed/Sliding
Remnant length	mm	Min. 110/Max. 450
Synchronization		PLC/Servo motor
Remote control		Colour touchscreen with library of 500 parts
Diameter change		
Partial change	mins	2 (in the same bearings)
Complete change	mins	10 (for all guide components)
Front rest		Fixed, 2 position pneumatic, automatic
Bar selection		Automatic
Driving system		
Motor		Servo
Drive		Belt
Guide		Hydrostatic bearings
Oil		80L, ISO VG 100
Options		
500 mm longitudinal movement		
Adjustable 2-positions longitudinal movement		
330 mm capacity extension		



SPRINT 565 S2

AUTOMATIC BAR FEEDER – LONG BARSTOCK



Designed for medium and large production runs in diameters ranging from 5 to 65 mm, the SPRINT 565 S2 is an automatic bar feeder for fixed headstock lathes. The SPRINT 565 S2 is equipped with reinforced feet which support the constituent parts of the device to ensure maximum stability and thereby prevent vibrations.

- Hydrobar® technology
- Rapid diameter changes
- Flexible configuration
- Colour touchscreen with parts library

Capacity		
Diameter	mm	ø 5 – 65
Bar length 2m/3m/12"/4m	mm	2200/3200/3800/4200
Loading system		Side chain elevators
Loading capacity		11 x ø 52 mm or 9 x ø 65 mm
Loading side		Right/Left
Applications		
Type of headstock		Fixed
Remnant length	mm	Min. 110 / Max. 450
Synchronization		PLC/Servo motor
Remote control		Colour touchscreen with library of 500 parts
Diameter change		
Partial change	mins	2 (in the same bearings)
Complete change	mins	10 (for all guide components)
Front rest		Fixed, 2 position pneumatic, automatic
Bar selection		Automatic
Driving system		
Motor		Servo
Drive		Belt
Guide		Hydrostatic bearings
Oil		80L, ISO VG 100
Options		
350 mm longitudinal movement		
330 mm capacity extension		



SPRINT S3

AUTOMATIC BAR FEEDER – LONG BARSTOCK



The SPRINT S3 is an automatic magazine bar feeder featuring high performance designed for small, medium and large diameter bars, permitting large production runs. The robust design and the guiding precision provided by the patented hydrostatic support in the bearing blocks ensures maximum RPM without vibrations.

- Hydrobar® technology
- Robust design
- Quick diameter changeover
- Round the clock production

Capacity		
Diameter	mm	ø 10 – 80
Bar length 3m/12'/4m	mm	3300/3800/4200
Loading system		Side chain elevator with ramp
Loading capacity	mm	700
Loading side		Front/Rear
Applications		
Type of headstock		Fixed
Diameter change		
Complete change	mins	15 (for all guide components)
Driving system		
Motor		Pneumatic
Drive		Chain
Guide		Hydrostatic/bearings
Oil		80L, ISO VG 100



ALPHA 212 S3

AUTOMATIC BAR FEEDER – LONG BARSTOCK



The Alpha 212 S3 is the ideal entry-level solution for loading small-diameter bars, from 2 to 12 mm.

Its straightforward use, compactness and efficiency are crucial production assets for fixed or mobile headstock lathes.

- Hydrobar technology
- Compact design
- Colour touchscreen remote control
- Maximum reliability and productivity

Capacity		
Diameter	mm	ø 2 – 12
Bar length 3 m	mm	3200
Loading system		Screw
Loading capacity		Up to 20 bars
Loading side		Right/Left
Application		
Headstock		Fixed/Sliding
Synchronization		Electromechanical
Remnant length		Min. 90 mm / Max. 300 mm
Remote control		Colour touchscreen
Longitudinal movement	mm	400
Changeover		
Diameter changeover	min	2 (within the guiding channel range)
Full diameter changeover	min	10 (for all guiding elements)
Driving system		
Motor		Servo motor
Drive		Belt
Guide		Hydrodynamic / Guiding channel
Oil		30 L, ISO VG 100
Options		
Adjustable 2-positions longitudinal movement		



ALPHA 320 S3

AUTOMATIC BAR FEEDER – LONG BARSTOCK



The Alpha 320 S3 is the LNS entry-level solution to load small diameter barstocks for fixed or sliding headstock machines. The easily adjustable loading fingers and manual front rest ensure optimum bar guidance and high performance. The Alpha 320 S3 is a highly productive and economical automatic bar feeding system for round bar stock diameters from 3 – 23 mm.

- Hydrobar® technology
- Compact design
- Easy to operate
- Highly productive and reliable
- User friendly remote control
- 2-positions longitudinal movement in option

Capacity		
Diameter	mm	Diameters 3 – 23
Bar length	3 m/4 m	mm
Loading system		Side load rack
Loading capacity	mm	270
Loading side		Right/left

Application		
Headstock		Fixed/sliding
Remnant length	mm	Min. 90/max. 400
Synchronisation		PLC/servomotor
Remote control		Colour touchscreen
Longitudinal movement	mm	430

Changeover		
Diameter changeover	mins	2 (in the area of the guide channels)
Full diameter changeover	mins	10 (for all guiding elements)

Driving system		
Motor		Servo
Drive		Chain
Guide		Guiding channel
Oil		30L, ISO VG 100

Options		
2-Positions longitudinal movement, adjustable up to 270 mm		
2-Positions longitudinal movement 350 mm		



ALPHA 538/552

AUTOMATIC BAR FEEDER – LONG BARSTOCK



The Alpha 538/552 is a high-performance and affordable solution to ensure maximum productivity for the loading of bar stocks from 5 to 52 mm for the Alpha 552 and 5 to 38 mm for the Alpha 538, designed for medium and long production runs on fixed or sliding headstock lathes. The guiding system consists of pushers and round bearings. For a total diameter changeover, these elements are quickly and easily replaced, without any tools.

- Reliable and easy to operate
- User friendly remote control
- Quick diameter changeover

Capacity		Alpha 538	Alpha 552
Diameter	mm	5–38	5–52
Bar length	mm	3200 mm / 4200 mm	
Loading system		Side load rack	
Loading capacity	mm	300	
Loading side		Front / rear	

Applications			
Headstock type		Fixed / sliding	
Remnant length	mm	Min 90 / Max 400	
Front rest		2-positions pneumatic	
Bar selection		Manual	
3S synchronization		Standard	Option
Z-axis retraction system	mm	470	350
Remote control		Color touch screen	

Diameter change			
Partial changeover		3 min (in the same guiding elements)	
Total changeover		10 min (for all guiding elements)	

Driving system			
Motor		Servo	
Drive		Chain	
Guiding		Hydrostatic bearings	
Oil		80L ISO VG 100	

Options			
2-positions longitudinal movement	mm	adjustable	–



QUICK LOAD SERVO 80 S2

AUTOMATIC BAR FEEDER – SHORT BARSTOCK



The Quick Load Servo 80 S2 is designed for automatic loading of short bars. The machine uses the proven concept of the Quick Load Servo III, and is especially adapted for working in standard applications.

- Compact, simple, easy to use design
- Automatic diameter set up
- Fully electrical
- Servo Motor LNS technology
- "EASY CLIC" pusher
- Adjustable loading ramp
- Integrated X or Z retraction

Capacity		
Diameter	mm	ø 6 – 80
Bar length	mm	350 – 1605 (limited to headstock length)
Loading system		Lateral magazine
Loading capacity	mm	650
Loading side		Front/Rear
Applications		
Type of headstock		Fixed
X or Z axis retraction	mm	640
Diameter change		
Diameter set up	sec	10 (automatic)
Complete change	mins	2 (including pusher)
Driving system		
Motor		Servo
Drive		Notched belt
Options		
Kit for "One Shot" shaft loading		
Orientation kit for square stocks		



QUICK LOAD SERVO III

AUTOMATIC BAR FEEDER – SHORT BARSTOCK



The Quick Load Servo III is an automatic magazine bar feeder for spindle length bar stocks. The features of the Quick Load Servo III allow many operations in a record time. The user friendly interface simplifies all current operations.

- Compact design
- Diameter change over completely automatic
- Different production applications available
- Integrated X or Z retraction

New option: now available with lift!

The bar stocks now can be brought with a fork lift or a crane directly on the ramp, saving manpower for the heavy lifting.

Capacity		
Bar diameter	mm	ø 6 – 120 (Weight limited to 67 kg per bar)
Bar length	mm	100 – 1600 (Weight limited to 67 kg per bar)
Loading system		Side load rack
Loading capacity	mm	1000
Loading side		Front/Rear
Applications		
Type of headstock		Fixed
X or Z axis retraction	mm	600
Diameter change		
Diameter setup	sec	10 (fully automatic)
Complete change	min	2 (including pusher)
Driving system		
Motor		Servo
Drive		Notched belt
Options		
Telescopic pusher		
Shaft loading kit		
Orientation kit for square bar stocks		
Kit "heavy bars" up to 80 kg per bar stock		
⚠ The bar length cannot exceed the spindle length		



ALPHA SL65 S

AUTOMATIC BAR FEEDER – SHORT BARSTOCK



The Alpha SL65 S is a competitive alternative for spindle length bar stock feeding. The Alpha SL65 S is designed for simple applications, especially for standard production parts, and for medium and large production runs.

- Small footprint
- Easy to use
- Easy diameter change over
- Integrated X or Z retraction

Capacity		
Diameter	mm	ø 6 – 65
Bar length	mm	300 – 1500 (limited to headstock length)
Loading system		Lateral magazine
Loading capacity	mm	600
Loading side		Arrière
Applications		
Type of headstock		Fixed
X or Z axis retraction	mm	X: 300/Z: 600
Diameter change		
Diameter set up	mins	5 (manua)
Complete change	mins	10 (with pusher)
Driving system		
Motor		Servo
Drive		Notched belt



PB 80

CHAMFERING MACHINE



The PB 80 is the ideal partner for automatic and manual bar feeders. The PB 80 offers an economical solution for bar end preparation. The PB 80 is used for chamfering, centering and turning.

- 3 different applications : Chamfer, Center, Turn
- Easy to use
- Economical

Diameter		
30° Chamfering	mm	ø 8 – 80
Turning	mm	ø 10 – 60
	mm	40 max. length
Centering		ø 8 – 80
Driving system		
Motor	kW	0.9/1.65
Drive		2 x 2 speeds
Speed 1	rpm	230/460
Speed 2	rpm	700/1400
Clamping system		
Chuck		3 jaws
Options		
Universal head "pencil sharpener" for chamfering bars ø 8 – 51 mm		
4 Jaws chuck		



SUPER HYDROBAR HS

MANUAL BAR FEEDERS



The Super Hydrobar HS is a manual bar feeder for small and medium production runs. The diameter range is designed for camshaft-controlled screw machines and CNC machines. The Super Hydrobar HS offers maximum flexibility in turning applications. The hydrodynamic support totally enclosed guiding tubes provide high performance with high reliability.

- Hydrobar® technology
- Large range of length and diameter available
- Quick diameter change over

Types	ø tubes	ø bars	Types	ø tubes	ø bars	Types	ø tubes	ø bars	Types	ø tubes	ø bars
HYS 6.68 HS	70-62-55-48-40-32	24-68	HYS 6.45 HS	47-42-36-30-24-16	8-45	HYS 3.28 HS	30-24-16	8-28	HYS 3.16 HS	18-13-6	2-16
HYS 6.65 HS	68-62-55-48-40-32	24-65	HYS 6.42 HS	44-40-34-28-22-14	6-42	HYS 3.26 HS	28-22-16	8-26	HYS 3.12 HS	14-10-6	2-12
HYS 6.60 HS	63-58-52-44-36-28	20-60	HYS 6.40 HS	42-38-34-28-22-14	6-40	HYS 3.25 HS	27-21-14	6-25	HYS 3.10 HS	11-8-6	2-10
HYS 6.55 HS	58-52-45-38-30-22	14-55	HYS 6.36 HS	38-34-30-24-18-12	4-36	HYS 3.24 HS	26-20-14	6-24	Other configurations on request		
HYS 6.52 HS	54-48-42-34-26-18	10-52	HYS 6.32 HS	34-30-26-21-16-10	3-32	HYS 3.22 HS	24-18-12	4-22			
HYS 6.50 HS	52-46-40-32-24-16	8-50	HYS 6.30 HS	32-28-24-19-14-8	3-30	HYS 3.20 HS	22-15-8	3-20			
HYS 6.46 HS	48-42-36-30-24-16	8-46	HYS 6.26 HS	28-24-20-16-12-8	3-26	HYS 3.18 HS	20-14-8	3-18			

Capacity		
Diameter	mm	ø 2 – 68
Bar length	mm	6000 max.
Loading system		Tube swing out system
Loading side		Right/Left
Applications		
Type of headstock		Fixed/Sliding
Diameter change		
Complete change	mins	1
Driving system		
Drive		Hydraulic pressure
Guide		Hydrodynamic/tube
Oil		120L, ISO VG 100
Option		
200 mm or 600 mm longitudinal movement		



SE 880

SPINDLE EXTENSION



The LNS SE 880 spindle extension can be used to load and guide bars up to 1600 mm in length, making it the perfect accessory to a short bar feeder. Thanks to the spindle length of the lathe and the additional spindle extension, 3m bars can be loaded and guided in half length. This reduces the number of remnants, extends autonomy and increases productivity.

The stability of the spindle extension SE 880 and its guiding tubes, for the diameter range of 8 to 80 mm, allow the system (hydrodynamic guiding tube) a low-noise and low-vibration guiding of the bar to machine parts with optimal cutting speeds.

Capacity		
Diameter	mm	ø 8 – 80
Bar length maximum	mm	up to 1600*
Permissible spindle length	mm	750 to 1200 max.
Spindle height	mm	920 to 1350
Specifications		
Guide		Hydrodynamic/Guiding tube
Oil		10L, ISO VG 100
Control		Via the QLSIII or QLS80S2

* depends on the lathe's configuration, to be confirmed when ordering



SPINDLE REDUCTION TUBES – SINGLE-PIECE

ACCESSORIES

Spindle reduction tubes are an indispensable accessory for lathes when working with bar material.

They significantly improve the quality of the guiding in the spindle area.

- Perfectly straight
- Lower vibrations
- Optimum speeds
- Longer tool life times
- Guiding adapted to the material diameter
- Simple installation and removal
- Diameter selection to the nearest mm

LNS spindle reduction tubes are made of drawn, sanded and galvanised steel tubes for spindle diameters ≤ 55 mm / ≤ 72 mm / ≤ 85 mm / ≤ 105 mm. The adaption parts are designed specifically for the clamping system diameter.

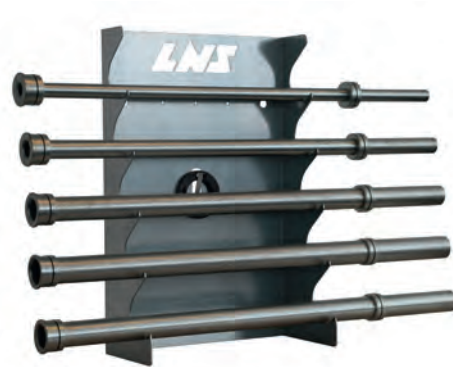

SPINDLE REDUCTION TUBES – MULTIPLE PIECES

ACCESSORIES

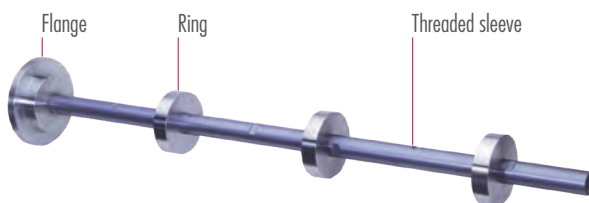

LNS manufactures and supplies top-quality liners designed for all lathes. This, in combination with LNS loading systems, guarantees improved guiding in headstocks at lower cost.

- Accurate straightness
- Balanced rotation
- Easy to adapt by the end-user
- Easy assembly and removal
- Wide diameter range available

LNS guarantees the best guiding in the headstock lathe with patented Spindle liners for all range of diameter.

LNS Spindle liners are composed of 3 different parts screwed together. A rear flange, a threaded sleeve, and a spacer. Assembly of the spindle liner is very easy.

All LNS bar feeders feature retraction systems which permit fast and easy access to the lathe for the changeover of spindle liners.

LNS offers two sizes of Spindle liners :

- A small size for headstocks up to max diameter 45 mm
- A large size for headstocks up to max diameter 80 mm

The spindle liners can be easily adapted to most different chucking systems by turning down the flange and the spacers to the appropriate headstock diameter.



COLLETS AND ROTATING SLEEVES

ACCESSORIES

LNS offers a range of collets from $\varnothing 0.8$ to $\varnothing 60$ mm, and rotating sleeves from $\varnothing 5.5$ to $\varnothing 50$ mm.

The collets are manufactured to very accurate manufacturing tolerances; their clamping force is calibrated to prevent tiresome adjustments of the infeed torques each time the gripper is changed.

The rotating endpieces have several rows of ball bearings to ensure a long service life, allowing them to turn at the highest rotation speeds.

These accessories are key factors in obtaining optimum productivity.

















TABLE OF CONTENTS

CHIP MANAGEMENT SYSTEMS

TURBO SF COMPACT	15	TURBO MH SERIES	18
TURBO HB		TURBO 3D	
TURBO MAGNETIC	16	CHIP HOPPER	19
TURBO MF2			
TURBO MS500	17		



SELECTION GUIDE

Material Type	Chip Shape	Model	Coolant Filtration	
Mixed material (Steel, aluminium, plastic)	 Stringy Coarse	 Standard duty Super heavy duty	No filtration	> TURBO HB
Ferrous material (Cast iron)	 Fine	 Magnetic belt	No filtration	> TURBO MAGNETIC
Mixed material (Brass, steel, cast iron, aluminium, ...)	 Fine	 Scraper belt	 500µm	> TURBO MS500
Mixed material (Brass, steel, cast iron, aluminium, ...)	 Mixed shape	 Hinge/scraper belt combined	 250µm - 500µm	> TURBO MH SERIES
Mixed material (Brass, steel, cast iron, aluminium, ...)	 Mixed shape	 Hinge/scraper belt combined	 50µm	> TURBO SFCOMPACT
Mixed material (Brass, steel, cast iron, aluminium, plastic)	 Mixed shape	 Hinge belt - Super heavy duty & Scraper belt	 50µm	> TURBO MF2



BELT TYPE

HINGE BELT

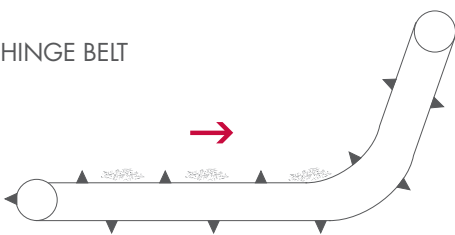

SCRAPER BELT

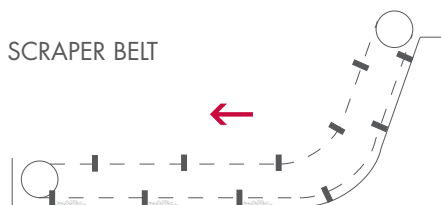

MAGNETIC BELT

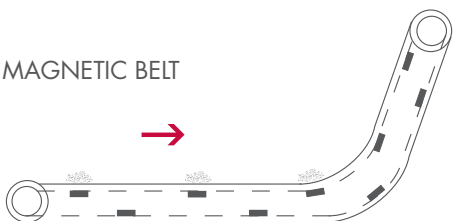

DISC BELT

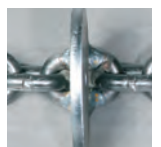
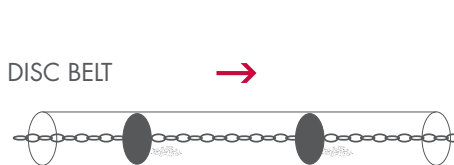



TURBO SF COMPACT

CHIP CONVEYOR WITH FINE FILTRATION TO 50µm – PATENT PENDING



Thanks to its filtration down to 50 µm, the SF Compact becoming the new benchmark for chip conveyors with built-in filtration. Self-cleaning filters have been built into the frame of the chip conveyor. Thanks to its patented double filter cleaning technology, with the SF Compact, LNS guarantees filtering levels identical or superior with filter drum conveyors with 50 µm filtration.

Modern machining processes produce a wide range of chip types from a huge variety of materials such as steel, titanium, brass, aluminium, etc. Chip shapes range from long chips, through balled chips, floating chips and to ultra-fine chips. The LNS Turbo SF Compact removes all types of chips originating from a wide variety of materials, while simultaneously filtering the cutting fluid down to 50 µm

BENEFITS OF THE LNS TURBO SF COMPACT:

- Removes all types of chips from a wide variety of materials
- Continuously supplies the machine with a 50 µm filtered cutting fluid, which ensures:
 - Reduced cleaning costs
 - Reduced downtime
 - No blockage of or damage to the cutting fluid pumps
- The patent pending filter system is built into the chip conveyor's fixed frame, hence:
 - Reduced space requirements
 - same as for a standard hinge conveyor
- In most cases, building into the machine's existing tank reduces the investment costs
- PLC control allows adjustment of the belt speed to reduce cutting fluid losses
- Hardened and specialized materials are used to ensure a long life
- Cost-effective operation:
 - Drive motor output 0.18 kW
 - Compressed air consumption 10 l/h

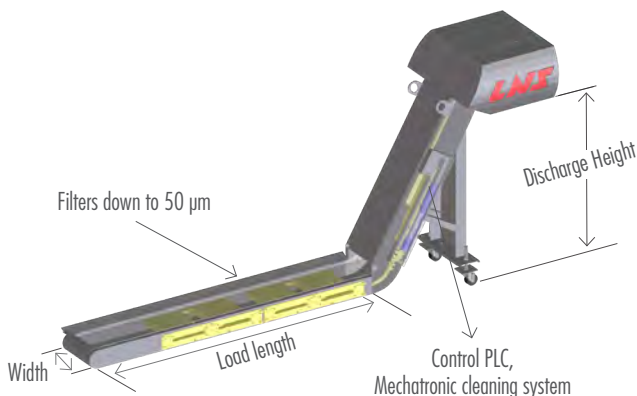

Features	
Filtration	Down to 50 Microns
Chip Shape	Mixed (long, stringy to fine)
Material Type	Mixed (suitable for most material types from stainless steel to brass and aluminium)
Discharge Height	800 mm – 3000 mm
Width	250 mm, 300 mm, 400 mm, 500 mm, 550 mm, etc.
Pitch	40 mm
Motor	0.18 kw
Air Consumption	10 L/hr
Filter Type	Self-cleaning filter box with woven stainless steel mesh



TURBO HB

NON FILTERING CHIP CONVEYORS



The Turbo HB is a standard conveyor used for chip removal where filtration is not necessary. The hinge belt can be used for all types of application and is the best choice for coarse and stringy chips.

Efficient Chip Removal

In the heaviest applications LNS uses specially-formed cleats to prevent curled chips from adhering to the belt, reducing wear and improving chip removal. Conveyor top cover height can be varied for special applications. Scraper cleats on the belts clean the entire surface of the bottom pan a minimum of two times per revolution and serrated cleats optimise the removal of stringy bushy chips.

Wear-resistant Design

Special abrasion-resistant alloy material is used in high wear locations, such as upper and lower curves. Belt rollers and hinge pins are hardened for long life, even in the toughest applications.

The best choice for :

- Coarse and stringy chips
- Mixed material, plastic
- No filtration

Options

- Air header
 - Small chips
 - Anti-adherence device
- Chip stripper bar
 - Stringy, bushy chips
- Variable speed control
 - Reduced coolant carry out

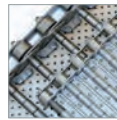

Variety of belts

For most efficient chip removal and coolant drainage, a wide variety of belt designs are essential to maximize chip removal success: dimpled and perforated.



TURBO MAGNETIC

NON FILTERING CHIP CONVEYORS

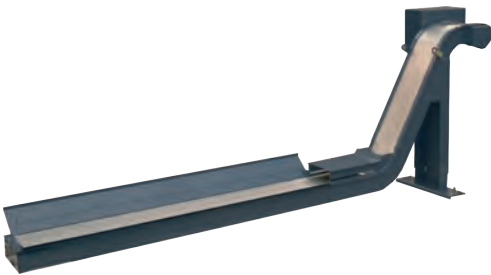

The Turbo Magnetic is specially designed for multi-tasking machines producing fine chips of ferrous material.

The Turbo Magnetic features a heavy gauge stainless steel slider face for a long life in extreme wear conditions. All moving parts are contained inside the conveyor's viton sealed frame so they are never exposed to machining contaminates. The conveyor belt is automatically tensioned.

Self-lubricated Track

No lubrication oil inside the conveyor to leak and contaminate the coolant.

Reduced Coolant Carry-out

A variable speed drive (AC Inverter) is standard on all units to maximize chip removal and minimize coolant loss.

Easily-Replaceable Magnets

LNS components, including individual magnet segments, are easily and economically replaced if the conveyor is accidentally damaged.

The best choice for :

- Fine chips
- Ferrous material (cast iron)
- No filtration



Belt construction

Magnets within the conveyor frame



Heavy duty stainless steel slideway



TURBO MF2 FILTERING CHIP CONVEYORS



Thanks to its two-storey conveyor concept: a hinge belt above of a scraper belt, the Turbo MF2/Turbo MF3 are conveyors designed to remove all chip shapes made of different material and to provide superior filtration down to 50µm.

Versatility

The upper conveyor separates heavy chip loads from the filtration drum. Ideal for multiple material applications, including material chunks, stringy, bushy, and large chips. Also for heavy chip loads from today's advanced machining techniques. The lower conveyor is a scraper-type, ideal for removal of small particles carried through the upper conveyor. Fines trapped by the filter drum are deposited on the incline.

Low maintenance

The self-cleaning filter drum provides particle-free coolant to 50µm for the most demanding machining applications. Extends coolant life and tooling life for cost-saving operation.

The best choice for :

- Mixed-shape chips
- Mixed material, plastic
- Filtration to 50µm



Filtration device
Sealed nylon filter drum with reliable heavy duty viton seal.

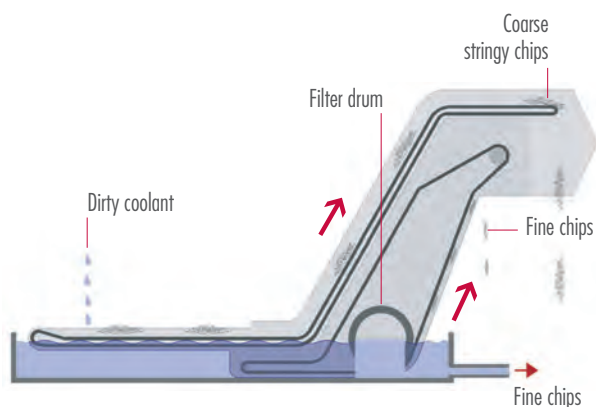

TURBO MS500 FILTERING CHIP CONVEYORS

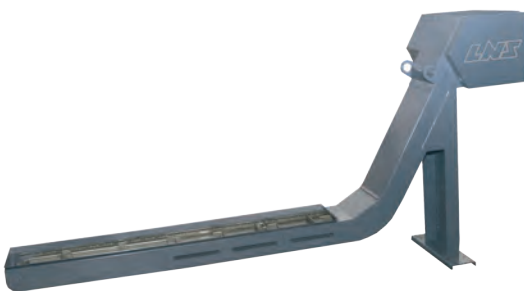

The Turbo MS500 handles medium to light chip loads including brass, steel, cast iron and aluminum all while incorporating coolant filtration to 500µm. This conveyor is ideal for removal of chips produced in the machining of cast components and billets.

Dry Chip Disposal

Designed to minimize coolant loss from the discharge. Less coolant loss and drier chips provide a more cost-effective, environmentally friendly operation.

Coolant Filtration

Each filter box is automatically cleaned whilst the conveyor is operating. The number of filter boxes required is related to the machine flow rate, assuring coolant flow and optimal filtration.

The best choice for :

- Fine chips
- Mixed material
- Filtration to 500µm



Filtration device
Removable heavy duty filter box

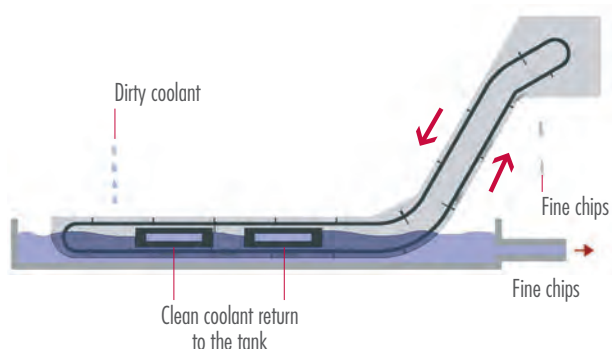



TURBO MH SERIES FILTERING CHIP CONVEYORS



Thanks to this revolutionary concept from LNS: Filtration boxes are used in conjunction with a hinge / scraper belt conveyor. The Turbo MH Series of conveyors are designed to remove all chip shapes made of different material incorporating self cleaning filtration. The hinge belt removes the chips in the same way as a normal hinge belt conveyor but the use of filter boxes ensures that all chips, greater than the filter box filtration level, cannot pass into the coolant tank. The fine chips are continually carried out of the bottom of the conveyor by the scrapers mounted to the hinge belt. This revolutionary design ensures minimal floor space is utilized while still covering a wide range of applications and filtration needs.

Low maintenance

The filter boxes provide particle free coolant to 250µm or 500µm (depending the type). This filtration reduces the amount of coolant tank maintenance, extends the coolant and tooling life for cost saving operation. Each filter box is automatically cleaned whilst the conveyor is operating.

Coolant filtration

The number of filter boxes required is related to the machine flow rate, assuring coolant flow and optimal filtration.

The best choice for :

- Mixed-shape chips
- Mixed material
- Filtration to 250µm or 500µm

Advantages

- Self cleaning filtration
- Very small footprint (same as a standard conveyor)
- Flexible design for various flow rates
- Handles most chip shapes and materials
- Competitive price
- Fits to most standard machine coolant tanks
- Robust construction

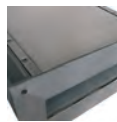

Filtration device
Removable heavy duty filter box

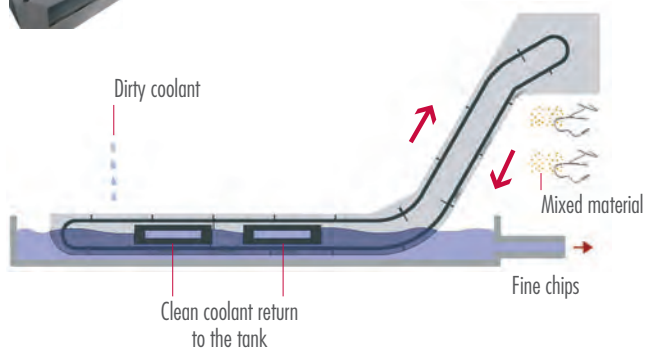

SYSTEM SCHEMATIC MH FILTERING CHIP CONVEYORS

As the scraper bars rotate around the end of the conveyor the small chips are transported around the curve and lifted to the top of the conveyor belt.

Brushes or wiper bars are used to wipe the box as the belt rotates. Any small chips that are wiped off by the brush / wiper fall to the bottom of the conveyor frame and are collected by the scraper bars.

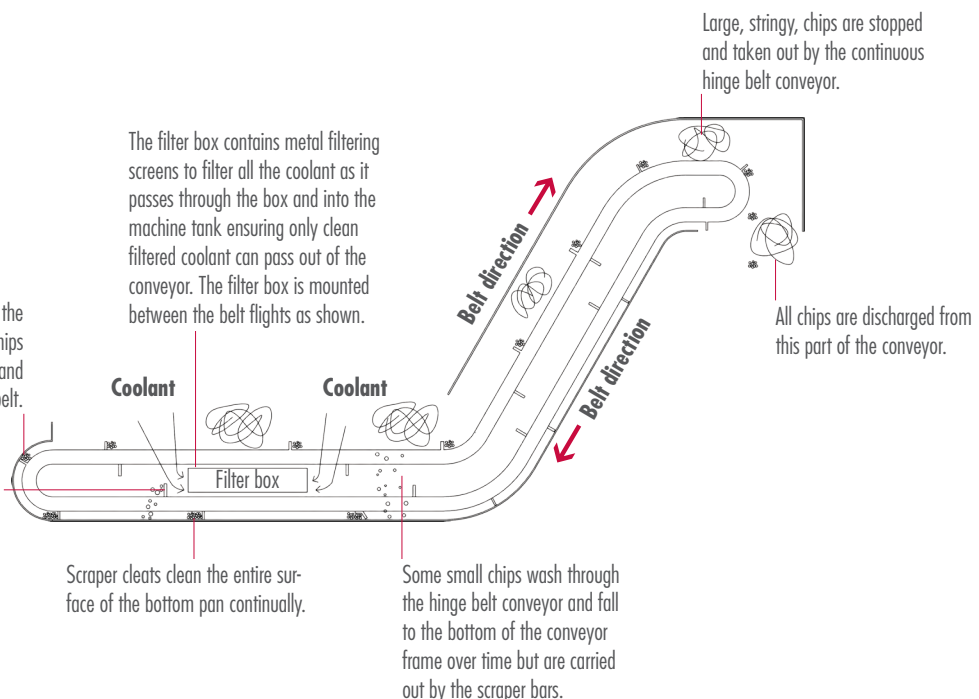



TURBO 3D CENTRAL PROCESSING

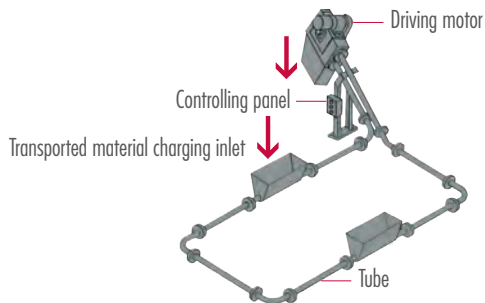

The Turbo 3D provides a complete workshop-integrated, material-conveying system. From your multi-tasking machines, material is removed through a piping network directly to an outdoor hopper or truck.

The system can fit almost any plant, thanks to its modular elements. At the lower point of the system, coolant recovery tanks can be easily installed.

Advantages of the system

- A fully-automated factory system capable of removing chips and different swarf from a number of machine tools at one time, and discharge can be positioned inside or outside the factory for disposal of chips.
- It creates a clean and tidy environment with substantial labour savings.
- Each and every system is designed to suit the particular factory.

System equipment

The system can be equipped with additional options.



CHIP HOPPER ACCESSORIES

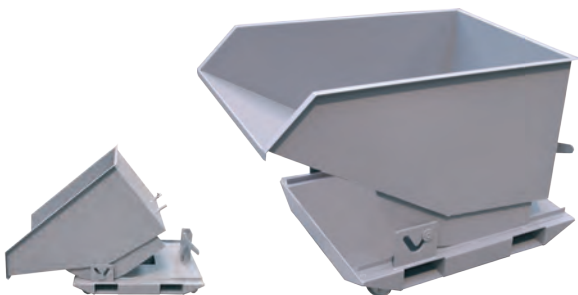

Capacity	Width	Length	Height
0.18 m ³	600 mm	1010 mm	650 mm
0.35 m ³	840 mm	1320 mm	840 mm
0.50 m ³	1100 mm	1270 mm	970 mm

LNS chip hoppers are the perfect accessory for any chip conveyor.

Their unique tipper system allows for secure unloading from a rack without manual intervention.

TABLE OF CONTENTS

COOLANT MANAGEMENT SYSTEMS

**INTEGRATED HIGH
PRESSURE COOLANT SYSTEMS**

20 PHASEP

21



INTEGRATED HIGH PRESSURE COOLANT SYSTEMS

The use of high pressure coolant can drastically increase the performance of a machine tool through a number of factors.

Heat is one of the major causes of tool failure. Normal flood coolant in many cases does not even reach the cutting edge. The temperature at the tool is often over 500°C. HPC keeps the temperature lower at the cutting edge and improves the cutting action of the tool.

High Pressure Coolant also helps to break chips by hitting the cutting area at high speed. In addition to this high pressure helps to evacuate the chips and stops them from falling back into the cut helping to prevent broken inserts caused by re-cutting chips.

Lubricity also plays an important role in metal cutting. HPC systems deliver the coolant between the cutting tool and the workpiece, dramatically improving the lubrication, tool life, and, in many cases, the surface finish.

In summary, metal can be cut at much higher surface speeds, improving productivity as well as lowering tooling cost.

The development teams at LNS use the latest CAD tools and specially chosen accessories, to ensure each coolant tank works with your machine tool and your application.

Our engineers are able to integrate a wide range of accessories such as pumps for high pressure coolant, frequency converters, coolant suction pumps, or fine filtration systems.

Our technical support team works closely with our customers to evaluate their exact requirements and create detailed specifications for production of the finished product.





PHASEP

TRAMP OIL REMOVAL SYSTEM



LNS PhaSep's patented oil removal technology can improve metalworking fluid life by 100%, drastically reducing the need for hazardous waste disposal, at the same time reducing cost on replacement coolant.

The design of machine tools means that from box ways and linear ways, either grease packs or oil, contaminate coolant resulting in bacteria, foul odour, and irritants. Mechanically it destroys the tooling through the deterioration of coolant.

Oil contamination is the number one cause of metal working fluid disposal. Metal working fluids lose valuable cooling and lubrication properties when contaminated with oil.

The unique floating pick-up skims the tramp oil and coolant mix from the top of the machine sump. As the liquid moves slowly through the patented steel coalescing plates, oil droplets as small as 20µ are separated from the coolant and rise to the top of the PhaSep unit.

When the oil layer builds up sufficiently in the unit, it passes over a specially-designed weir, and is trapped away from the clean coolant. The oil can then be removed periodically through the waste oil drain.

Coolant, cleaned of 99% of contaminated oils, is returned directly to the machine sump.

Technical specifications

Mini	2.25 to 3.4 L/Min Process Rate, 432 x 406 x 610 mm
	Coolant tank processing up to 400 L
Junior	6.8 L/Min Process Rate, 610 x 406 x 610 mm
	Coolant tank processing up to 800 L

System schematic

The oil collects on the plate packs and is encouraged to the surface.

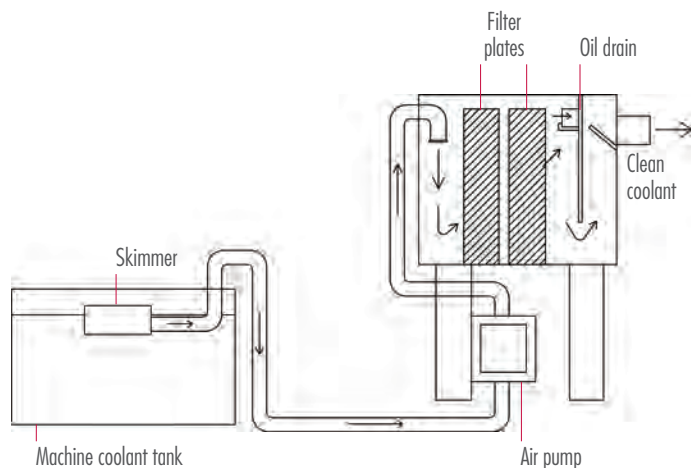

TABLE OF CONTENTS

AIR FILTRATION SYSTEMS

FOX WS 2 SERIES

22

FOX SC 500

23

FILTRES ET ACCESSOIRES POUR FOX WS2

23



FOX WS 2 SERIES

AIR FILTRATION SYSTEMS



Fox WS series is the perfect solution for the elimination of oil mist typical of metal cutting applications.

With its small and compact dimensions the WS series integrates perfectly with the machine tool design and thanks to its control panel it can be easily interfaced.

With the optional additional Hepa filter module it can completely eliminate dry smoke problems providing a 99.95 % MPPS filtration efficiency level (EN 1822).

Models available

- Fox WS 2 250
- Fox WS 2 500
- Fox WS 2 1000
- Fox WS 2 1500
- Fox WS 2 2000

Technical specifications

		Air flow (m ³ /h)	Static pressure (Pa)	Motor (kW)	Weight (kg)	Sound level (db (A))
WS 2 250	50 Hz	240	470	0.24	28	62
	60 Hz	285	600	0.3	28	64
WS 2 500	50 Hz	470	610	0.37	35	65
	60 Hz	560	890	0.4	35	67
WS 2 1000	50 Hz	950	950	0.75	55	71
	60 Hz	1130	1420	0.9	55	73
WS 2 1500	50 Hz	1450	1260	1.5	75	74
	60 Hz	1720	1800	1.8	75	76
WS 2 2000	50 Hz	1800	1720	2.2	85	76
	60 Hz	2120	2300	2.6	85	78

Options

- HEPA filter module
- Relay remote
- Timer
- LED lights alarm when filter maintenance is required

Designed for

All types of machine tools and industrial operation which use coolants (water soluble oil or straight oil) and for EDM machines.



FOX WS 2 FILTERS AND ACCESSORIES



The filters are the core of an air filtering system. In order to guarantee optimum efficiency, LNS filters are specific to the operating scenario — emulsion, oil, high pressure, spark machining — and developed to give the FOX WS 2 a high-performance filtering quality and maximum longevity. For strict requirements, final-stage HEPA filters provide optimum filtering.

LNS offers specific accessories kits to ensure successful machine integration, whether in terms of accessibility, space saving in the workshop, or fire safety.

Accessories

- telescopic stand
- mounting frame
- flange with built-in air outlet
- fire protection valve



FOX SC 500 SPRAY CABIN



Fox SC 500 is the solution to eliminate pollution generated by the cleaning of oily parts with an airgun. This mobile and compact unit ensures high-performance filtration. The unit is equipped with a standard electric motor [V/Hz] 230/50 or with a three-phase motor [V/Hz] 230/3/50 - 400/3/50 as an option.

- Mobile and compact
- Easy connection to standard wall plug
- High efficiency filtration > 99% (AFNOR 44060)
- Washable prefilter
- Low noise level
- Low electrical consumption

Technical specifications

	Nominal air flow (m ³ /h)	Static pressure (Pa)	Sound level (db(A))	RPM (min-1)	Motor (kW)	Voltage/ Phase/ Frequency (V/Hz)	Weight (Kg)
50 Hz	750	610	67	2790	0.37	230/1/50	70
60 Hz	900	890	69	3350	0.40	115/1/60	70

THINK GLOBAL, ACT LOCAL



QUALITY COMMITMENT

LNS provides innovative peripherals for machine tools combined with tailor-made solutions and services, across the world.

To maintain our position as market leader, we are committed to continuously improving the skills of our teams, our processes and our products to ensure we meet and exceed our customers' expectations.

QUALITY OBJECTIVES

- Maintaining and improving our customer focus, whilst respecting or exceeding their requirements by creating tailored products and services.
- Developing our products, services and processes thanks to continuous improvement initiatives.
- Continually improving our skills and the level of knowledge of our employees through training tailored to our products, services and processes.

DELIVERY

We understand that missed or late deliveries are detrimental and costly, which is why we are continually striving to improve our manufacturing processes to meet, and even exceed, your expectations.

COMMISSIONING

To ensure your LNS peripheral is up and running quickly and efficiently anywhere in the world, our factory-trained, experienced and certified technicians follow precise installation procedures for each product, ensuring successful commissioning.



TRAINING

Our key objective is to have a global presence which will enable our customers to improve their productivity, thereby increasing their competitiveness and profitability. To enable this, we have trained up a dedicated team of more than 200 highly qualified professionals. This means we are able to offer training to our customers during installation of our products, allowing them to get the very best from their LNS product.



PRODUCTIVITY

Your partner in productivity, LNS not only offers you the latest technology in the industry in terms of products and performance, this is combined with an exceptional technical service and genuine customer support. Our service team, present across the world, ensures you get the best possible use from your LNS products, giving you maximum return on investment.



TELEPHONE SUPPORT

Thanks to the teams at LNS, which have been loyal for many years, we have the experience and expertise needed to analyse and resolve even the most complex of problems without delay.

This easy-to-access troubleshooting service ensures you can minimise downtime and maximise productivity.



REPAIR & SPARE PARTS

Even the highest quality machines experience wear over time. When your equipment needs repairing, the LNS technical service team, boasting unrivalled experience and trained across the entire range of products, will ensure production can be restarted without delay.

This also means that we are able to help our customers resolve the most tricky application problems, deliver on time, provide a professional installation service and deliver spare parts quickly, and to do so across the globe.

LNS LEXICON

BAR FEEDING SYSTEMS

DEVICE RETRACTION

The device retraction system is intended to facilitate access to the lathe for changing the spindle liners or for carrying out maintenance or repairs.

Depending on the model of bar loader, LNS offers three different systems: lengthways retraction, sideways retraction or a swing out system.

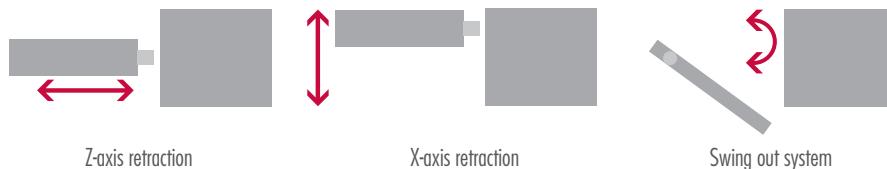

EVACUATION OF REMNANTS

LNS has two remnant evacuation systems :

- The remnant is pushed forward by the next bar into the lathe's part collector.
- The remnant is pulled back across the spindle and deposited in a tray located behind the bar feeder.

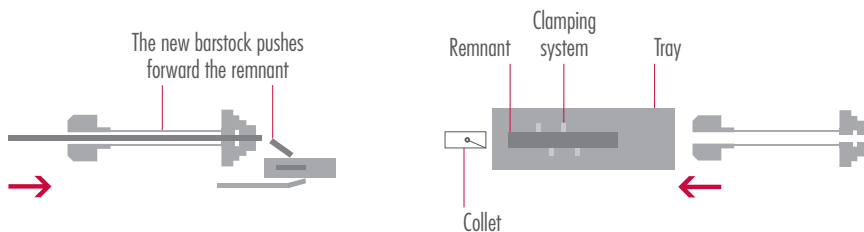

GUIDANCE

LNS offers three solutions to ensure perfect guidance for bars of different diameters. For the smallest diameters, LNS guides the bar along its entire length in a closed tube. For diameters from 2mm to 36mm, LNS offers

hydrodynamic channels. For diameters above 36mm, LNS guides the bars in hydrostatic bearing elements.

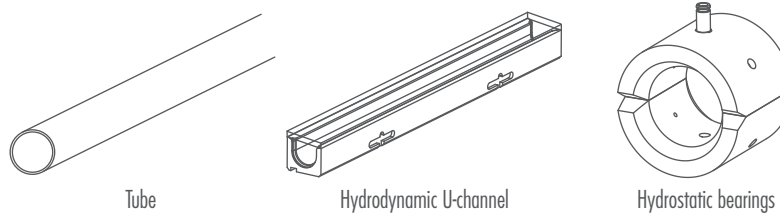

HYDROBAR®

Pressurized oil is introduced to the inside of the guiding tube, guiding channels or hydrostatic bearing elements. An oil film forms and separates the bar to be machined from the guide element. The more the rotation speed increases, the

greater the hydrodynamic effect. LNS equips all its loaders with the Hydrobar® system.

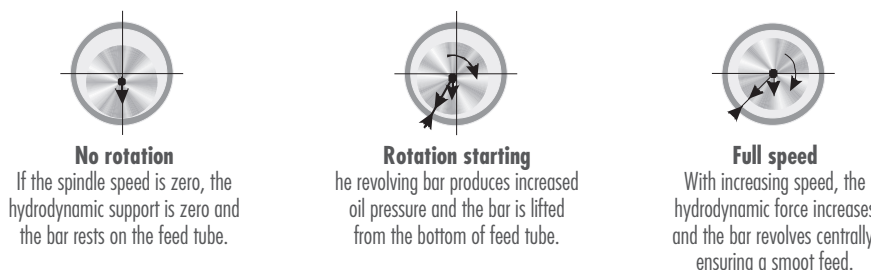

LNS LEXICON

BAR FEEDING SYSTEMS

FRONT REST

To ensure optimum guidance closest to the entrance of the lathe spindle, LNS equips its bar loaders with a front rest. This system guarantees rotation speeds

with no vibration along the entire length of the bar. The front rest is the last guide element in contact with the bar before the entrance of the lathe spindle.

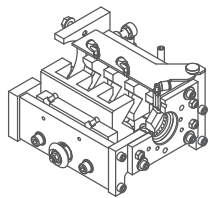

Automatic front rest

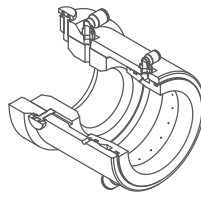

Standard fixed front rest

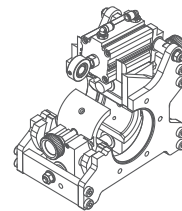

2-positions front rest

SYNCHRONIZATION

LNS synchronization is an electronic system which enables the movements of the headstock to be synchronized to those of the loader pusher. By means of a servo motor controlled by an SPS, the loader detects and anticipates

movements of the headstock. At the headstock advance speeds used on today's lathes, this is a decisive assurance to prevent bars from buckling.

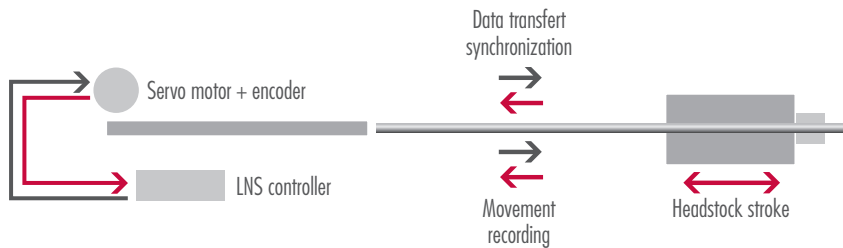

STRAIGHTNESS

If a bar is not straight, it can create vibrations as it rotates, and thus affects performance. Above 0.5mm per meter, a bar is not considered straight.

- The bars can be bent along their entire length.
- The bars be bent at the end as a result of the manufacturing process. In this case it is advisable to lathe the bent end first in order to avoid transmitting the vibrations along the whole bar while it rotates.



COOLANT MANAGEMENT SYSTEMS

COOLANT FILTRATION

LNS uses 3 primary types of filtration. For coarse filtration where it is necessary to remove particles to 250µ, self cleaning filter boxes are used where flat screens are contained in removable boxes within the conveyor frame. For higher level filtration to 50µ a self cleaning filter drum is used where a screen

is wrapped around a sealed drum that is contained within the conveyor frame. For very fine filtration to as little as 5µ filter bags are used, these are material sacks that need to be replaced periodically.

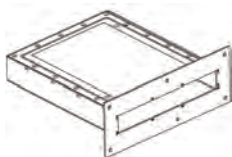

Filter box

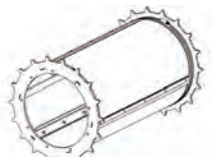

Filter drum



Filter bag



SWITZERLAND

LNS EUROPE
Rte de Frinwillier
2534 Orvin
Tel: +41 (0)32 358 02 00
Fax: +41 (0)32 358 02 01
LNS@LNS-europe.com
www.LNS-europe.com



GERMANY

LNS Deutschland GmbH
Mollenbachstrasse 10
71229 Leonberg
Tel: +49 (0)7152 3379-0
Fax: +49 (0)7152 3379-100
LNS.de@LNS-europe.com
www.LNS-europe.com



FRANCE

LNS France
44, Impasse des Troènes
74800 Amancy
Tel: +33 (0)4 50 03 93 32
Fax: +33 (0)4 50 03 93 34
LNSfrance@LNS-europe.com
www.LNS-europe.com



ITALY

LNS Italia srl
Via Mons. Colombo 34
21053 Castellanza – VA
Tel: +39 (0)331 501 901
Fax: +39 (0)331 482 101
LNS.it@LNS-europe.com
www.LNS-europe.com



TURKEY

LNS Makine San.Tic.A.Ş.
Serifali Mh.
Hattat Sk 14
34775 Ümraniye-Istanbul, Turkey
Tel: +90 216 364 10 56
Fax: +90 216 364 10 60
ricyer@LNS-europe.com
www.LNS-europe.com

**Find our complete agent and
service centers network on
WWW.LNS-GROUP.COM**



UNITED KINGDOM

LNS Turbo UK Limited
Waterside Park, Valley Way,
Wombwell
Barnsley S73 0BB
Tel: +44 (0)1226 27 00 33
Fax: +44 (0)1226 27 00 44
sales@LNSturbo.com
www.LNS-europe.com



AMERICA, MEXICO, CANADA

LNS America, Inc.
4621 East Tech Drive
Cincinnati, OH 45245
Tel: +1 513 528 5674
Fax: +1 513 528 5733
sales@LNSamerica.com
www.LNS-america.com



CHINA

LNS (China) Co., Ltd.
No.289, Quande Rd., Wujiang Economic &
Technical Development Zone, Wujiang Dist.,
Suzhou City, Jiangsu Province, P. R. C.
Tel: +86 512 6327 0828
Fax: +86 512 6327 0827
sales.cn@LNS-asia.com
www.LNS-asia.com



JAPAN

LNS Japan KK
Ushi 38-1, Dourin Machi
Nomi Shi, Ishikawa Ken
929-0125 Japan
Tel: +81 761-55-2058
Fax: +81 761-55-0956
mail@LNS-japan.com
www.LNS-japan.com



MALAYSIA

LNS Asia (Malaysia) SDN. BHD.
No.29, Jalan Permas 9/12
Bandar Baru Permas Jaya
81750 Masai, Johor
Tel: +607-388 5414
Fax: +607-388 5597
sales.ma@LNS-asia.com
www.LNS-asia.com



SOUTH KOREA

LNS Korea Co., Ltd.
4F Crystal B/D 1043, Ori-ro,
Gwangmyeong-si, Gyeonggi-do
14284, Rep. of KOREA
Tel: +82 2 3436-6187
Fax: +82 2 3436-6189
sales.ko@LNS-asia.com
www.LNS-asia.com



TAIWAN

LNS Asia SA, Taiwan Branch
No.133, Lane 418, Sec. 3, Xinan Rd.,
Wuri District, Taichung City 414
Taiwan R. O. C.
Tel: +886-4-2335 4920
Fax: +886-4-2335 4929
sales.tw@LNS-asia.com
www.LNS-asia.com



THAILAND

801/66-67 (Wang Thong Trade Center Village),
Moo8, Phahonyothin Rd., Kukot, Lamlukka,
Pathum Thani 12130, Thailand
Tel: +66 2992 6066
Fax: +66 2992 6068
sales.th@LNS-asia.com
www.LNS-asia.com

DISTRIBUTOR:

LNS®

www.LNS-europe.com